

LSD linear sectored slot diffusers



MADEL®

The **LSD** series linear diffusers are designed to combine the aesthetics with the technical performance.

They can be mounted in false ceilings or suspended from the ceiling.

They allow the formation of diffuser continuous lines, with active and inactive areas, without breaking the uniformity of the whole.

They are suitable both for supply and return.

By adjusting their blades, sectored each 100mm, it is possible to obtain a horizontal distribution of the air in one or the other direction or its vertical projection without change the volume of air.

The **LSD** diffusers admit a flow variation of 60% keeping the air stream stable.

These diffusers can be used from 2,6 up to 4 metres high and at a temperature differential up to 12° C.

LSD-AR

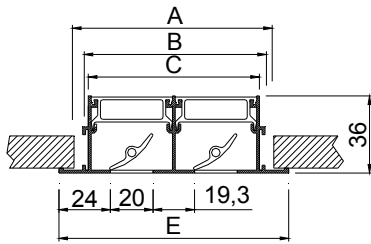

N°VIAS	E	A	B	C
1	68	55	47	40
2	107	95	86	80
3	147	134	125	119
4	186	173	165	159

CLASSIFICATION

LSD-AR Diffuser with end borders included. Suitable for lengths ≤ 2 m.

...-ARI Diffuser with an end border on the left side, required to form lines >2 m.

...-ARD Diffuser with an end border on the right side, required to form lines >2 m.

...-INT Diffuser without end borders, required to form lines > 4 m.

LSD-MOD Modular linear LSD diffuser.

MATERIAL

Diffuser constructed from aluminium and deflection vanes from PVC in black colour.

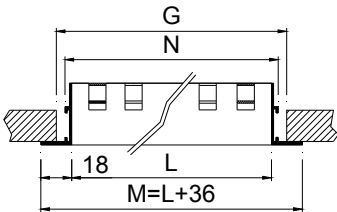

L	M	N	G
500	536	507	516
1000	1036	1007	1016
1200	1236	1207	1216
1500	1536	1507	1516
2000	2036	2007	2016

LSD-MOD

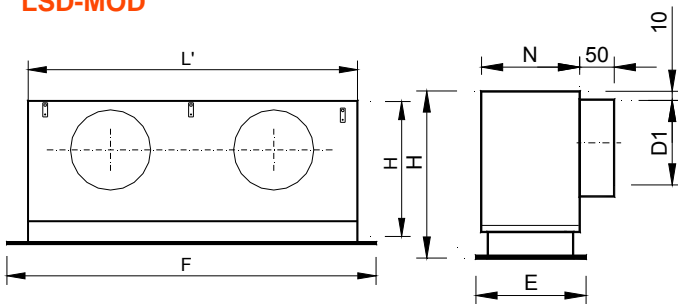

Dim.	F	E	L'	H	D1	N
1-1200x300	1195	295	1145	256	1/158	69
2-1200x300	1195	295	1145	256	1/158	108
3-1200x300	1195	295	1145	296	2/198	147
4-1200x300	1195	295	1145	296	2/198	186
1-1200x600	1195	595	1145	256	1/158	69
2-1200x600	1195	595	1145	256	1/158	108
3-1200x600	1195	595	1145	296	2/198	147
4-1200x600	1195	595	1145	296	2/198	186
1-1350x335	1345	330	1345	256	1/158	69
2-1350x335	1345	330	1345	256	1/158	108
3-1350x335	1345	330	1345	296	2/198	147
4-1350x335	1345	330	1345	296	2/198	186
1-1350x675	1345	670	1345	256	1/158	69
2-1350x675	1345	670	1345	256	1/158	108
3-1350x675	1345	670	1345	296	2/198	147
4-1350x675	1345	670	1345	296	2/198	186

A90/LSD

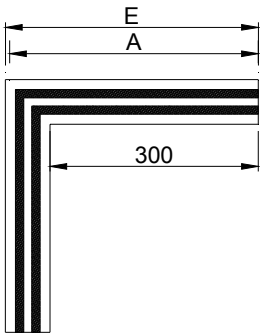

NºVIAS	E	A
1	368	358
2	407	397
3	447	437
4	486	476

LSD-AR + PLSD...-R

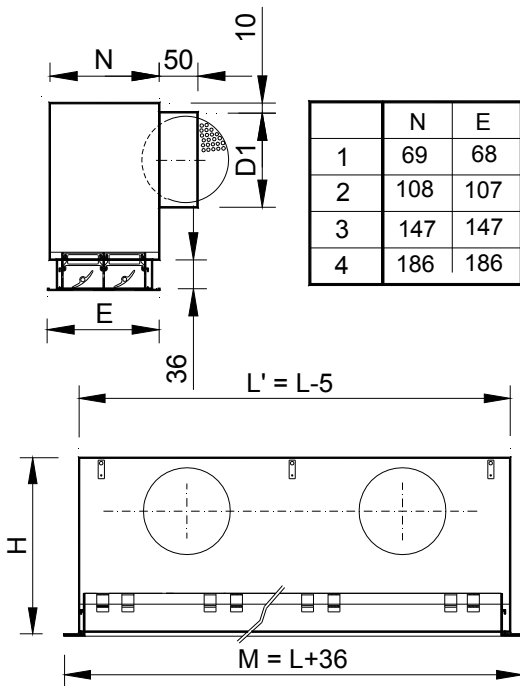

	N	E
1	69	68
2	108	107
3	147	147
4	186	186

	L ≤ 0,5		L ≤ 1		L ≤ 1,2		L ≤ 1,5		L ≤ 2	
	H	D1	H	D1	H	D1	H	D1	H	D1
1	256	1/158	256	1/158	256	1/158	256	1/158	256	2/158
2	256	1/158	256	1/158	256	1/158	256	2/158	256	2/158
3	296	1/198	296	1/198	296	2/198	296	2/198	296	2/198
4	296	1/198	296	1/198	296	2/198	296	2/198	296	2/198

ADDITIONAL ACCESSORIES

A90/LSD Inactive diffuser without end borders, making a 90° angle.

PLSD Plenum box with lateral circular connection. It includes supports to hang from the ceiling. Made in galvanised steel.

...-R Plenum box with a flow damper in the spigot.

.../AIS/ Plenum box thermo acoustically insulated by a foam with a coefficient of thermal conductivity of 0,04 w/mk. This foam complies with the fire reaction specifications:

- UNE 23-727 M2
- NFP 92-501 M2
- DIN 4102 M2

FIXING SYSTEMS

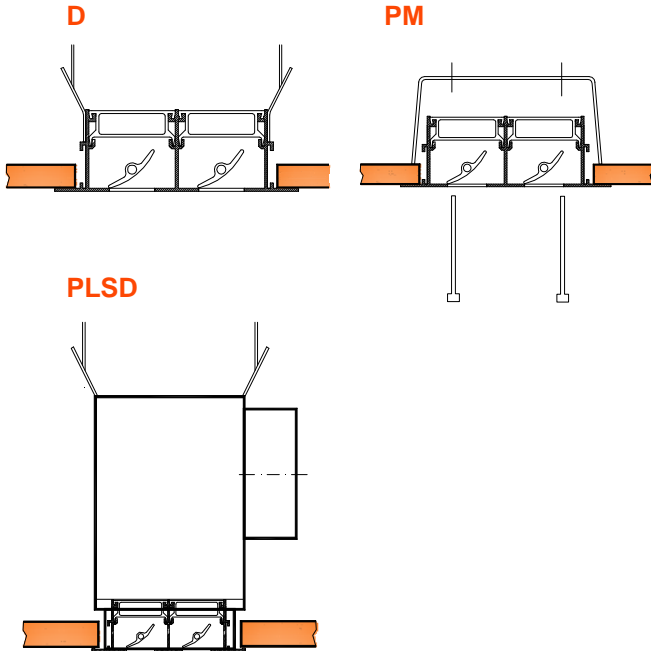

(D) Support brackets to hang LSD or LSD+PLSD from the ceiling.

(PL) Connection into PLSD+PML plenum box by screws, to hang from the ceiling. This system simplifies and facilitates the assembly and disassembling of the diffuser into the plenum box.

(PM) Set of crossbars for installation of the diffuser without plenum in false ceiling.

FINISHES

- AA** Matt silver anodised.
- M9016** Painted in white similar to RAL 9016.
- R9010** Painted in white RAL 9010.
- RAL...** Painted in other RAL colours.
- .../AB/** Vanes from PVC in white colour.

SPECIFICATION TEXT

Supply and mounting of linear slot diffuser with sectored adjustable vanes series **LSD-AR+PLSD-R AA 1x558** constructed from aluminium and anodised in matt silver **AA**. With lateral circular connection plenum box and air flow damper in the spigot **PLSD-R**. Manufacturer **MADEL**.

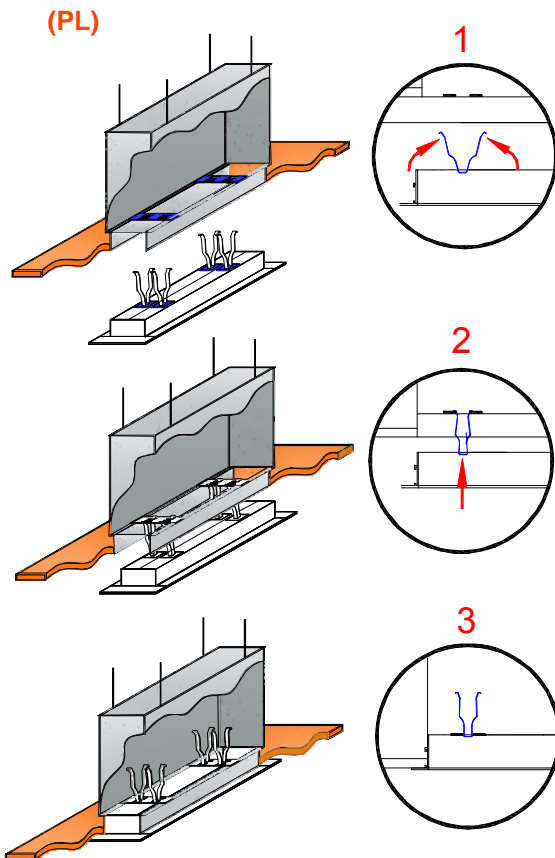

LSD

VELOCIDAD RECOMENDADAS.

VIAS	Vmin (m/s)	Vmax (m/s)
1	2.5	4.5
2	2.5	4.5
3	2.5	4
4	2.5	4

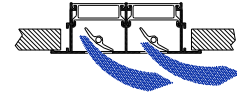
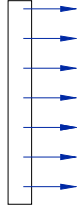

VELOCIDAD LIBRE, PERDIDA DE CARGA Y POTENCIA SONORA, ALCANCE CON EFECTO TECHO: 1 DIRECCIÓN.
LSD-AR + PLSD

SECCION LIBRE DE SALIDA DEL AIRE (m2).

	0.5 m	1 m	1.5 m	2 m
1	0.0043	0.0087	0.013	0.0174
2	0.0087	0.0174	0.0261	0.0348
3	0.013	0.0261	0.0391	0.0522
4	0.0172	0.0348	0.052	0.0696

VALORES DE CORRECCION PARA DPT Y Lwa1.
LSD-AR + PLSD-R

	0.5 m			1 m			1.5 m			2 m		
	100%	50%	0%	100%	50%	0%	100%	50%	0%	100%	50%	0%
1 Dpt	0.95	2.35	3.15	1	1.4	2.2	1	1.4	2.2	1.1	2.5	3.3
1 Lwa1	-6	-3	-3.6	0	0.8	0.4	+1.2	+1.9	+1.4	-2	-	-1.6
2 Dpt	0.98	2.48	3.25	1	1.5	2.3	1	1.5	2.3	1.2	2.7	3.5
2 Lwa1	-4	-3.6	-3.1	0	+0.6	+0.6	+2.3	+3.2	+3.1	0	+1	+1.2
3 Dpt	0.96	2.26	3.36	1	1.3	2.4	1	1.3	2.4	1.3	2.4	3.5
3 Lwa1	-7	-6	-6	0	+0.9	+0.5	-2.7	-2.6	-2.7	-1.4	-1.1	-1.1
4 Dpt	0.95	2.35	3.05	1	1.4	2.1	1	1.4	2.1	1.1	2.5	3.2
4 Lwa1	-3.4	-1.4	-2.5	0	+1.5	+1.2	-1.8	-1.1	-1.2	-1.7	-1	-1.1

$$Dpt1 = Kp \times Dpt$$

$$Lwa1 = Lwa + Kf$$

FACTOR DE CORRECCION DEL ALCANCE KL

	0.5 m	1 m	1.5 m	2 m
1	0.71	1	1.07	1.14
2	0.73	1	1.09	1.15
3	0.74	1	1.11	1.2
4	0.75	1	1.25	1.25

$$AL'02 = Kl \times AL02$$

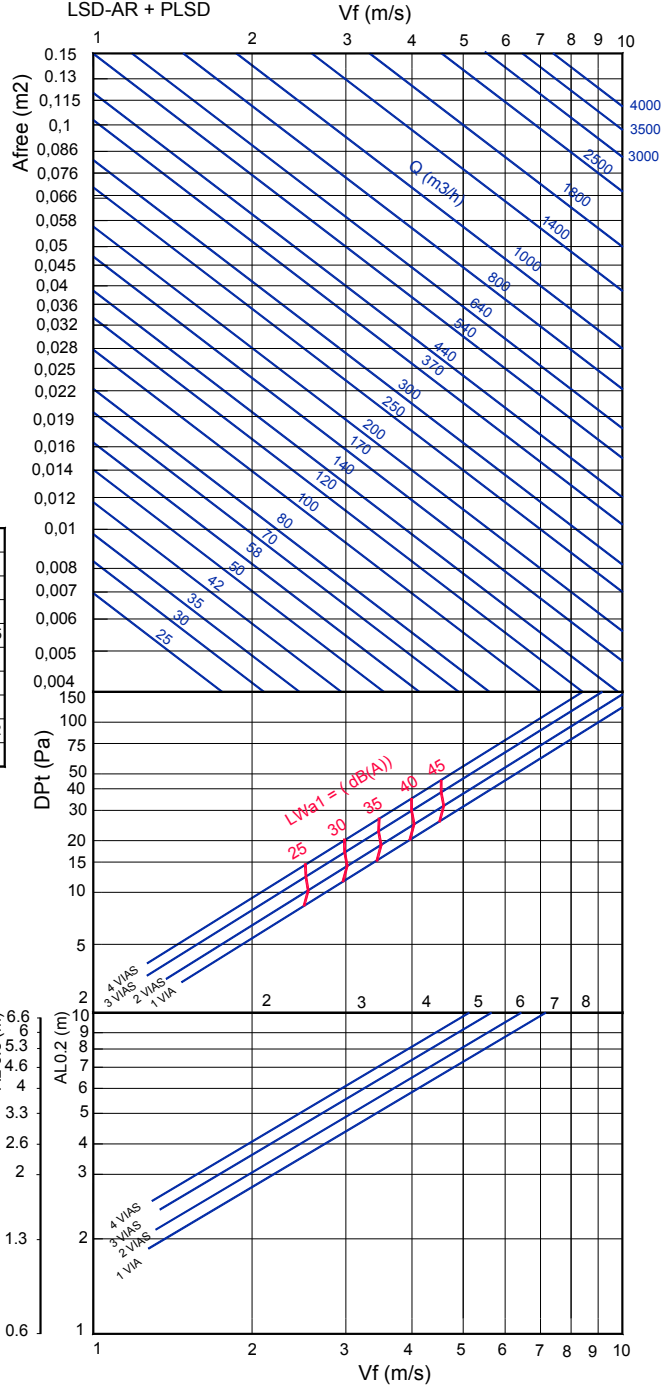
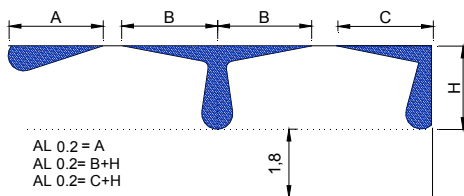

Nota: En MadelMedia Espectro por banda de octava en Hz.

LSD

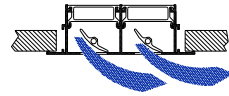

FACTOR DE CORRECCION DE LA DIFUSIÓN VERTICAL (bv) PARA DT (-).

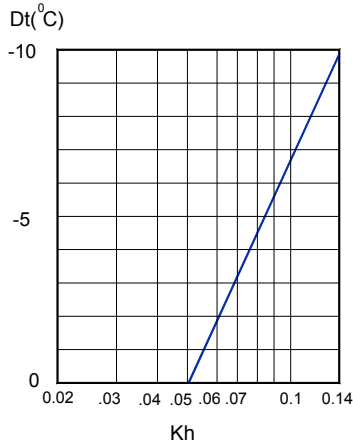

Kh = Factor de corrección de la difusión vertical.

FACTOR DE CORRECCION DEL ALCANCE (L0.2) DT (-).

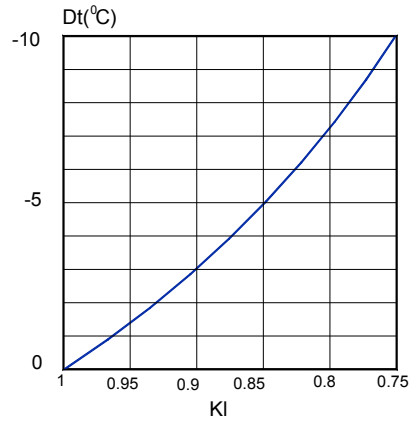

Kl = Factor de corrección del alcance.

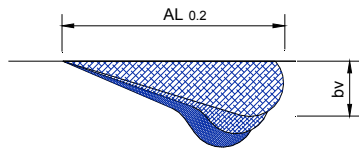

$$bv = Kh \times AL_{0.2}$$

$$AL'_{0.2} (Dt < 0) = Kl \times AL_{0.2}$$

RELACION DE TEMPERATURAS.

$$\frac{Dt_l}{Dtz} = \frac{t_{local} - t_x}{t_{local} - t_{imp}}$$

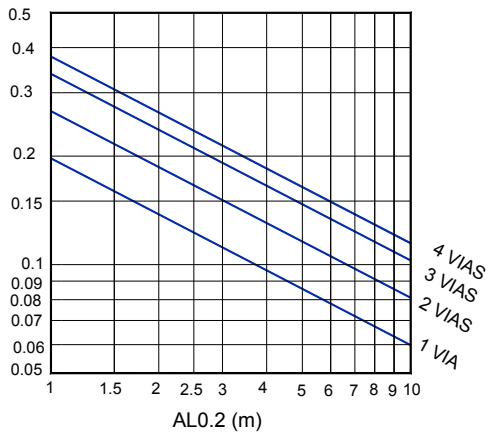

RELACION DE INDUCCION.

$$i = \frac{Q_r}{Q_0} = \frac{Q_{total\ en\ x}}{Q\ de\ impulsión}$$

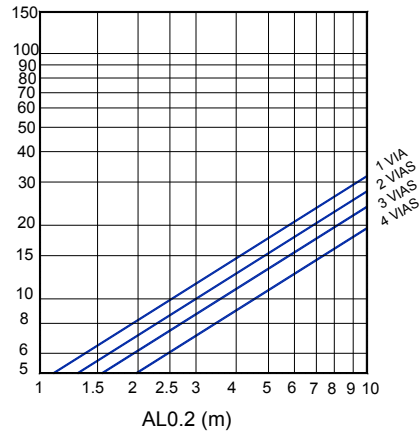

LSD

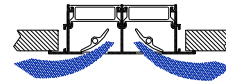

VELOCIDAD RECOMENDADAS.

VIAS	Vmin (m/s)	Vmax (m/s)
2	2.5	4.5
4	2.5	4

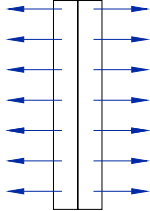

VELOCIDAD LIBRE, PERDIDA DE CARGA Y POTENCIA SONORA, ALCANCE CON EFECTO TECHO: 2 DIRECCIONES.

SECCION LIBRE DE SALIDA DEL AIRE (m2).

	0.5 m	1 m	1.5 m	2 m
1	0.0043	0.0087	0.013	0.0174
2	0.0087	0.0174	0.0261	0.0348
3	0.013	0.0261	0.0391	0.0522
4	0.0172	0.0348	0.052	0.0696

VALORES DE CORRECCION PARA Dpt Y Lwa1.

	0.5 m			1 m			1.5 m			2 m			
	100%	50%	0%	100%	50%	0%	100%	50%	0%	100%	50%	0%	
2	Dpt	0.98	2.48	3.25	1	1.5	2.3	1	1.5	2.3	1.2	2.7	3.5
	Lwa1	-3.9	-3.5	-3	0	+0.6	+0.6	+2.3	+3.2	+3.1	-0.3	+0.9	+1.1
4	Dpt	0.95	2.35	3.05	1	1.4	2.1	1	1.4	2.1	1.1	2.5	3.2
	Lwa1	-3.6	-1.5	-2.5	0	+1.5	+1.1	-1.5	-1.3	-1.4	-1.8	-1.2	-1.3

$Dpt1 = Kp \times Dpt$

$Lwa1 = Lwa + Kf$

FACTOR DE CORRECCION DEL ALCANCE KL

	0.5 m	1 m	1.5 m	2 m
2	0.6	1	1.17	1.3
4	0.767	1	1.2	1.17

$AL'02 = KI \times AL02$

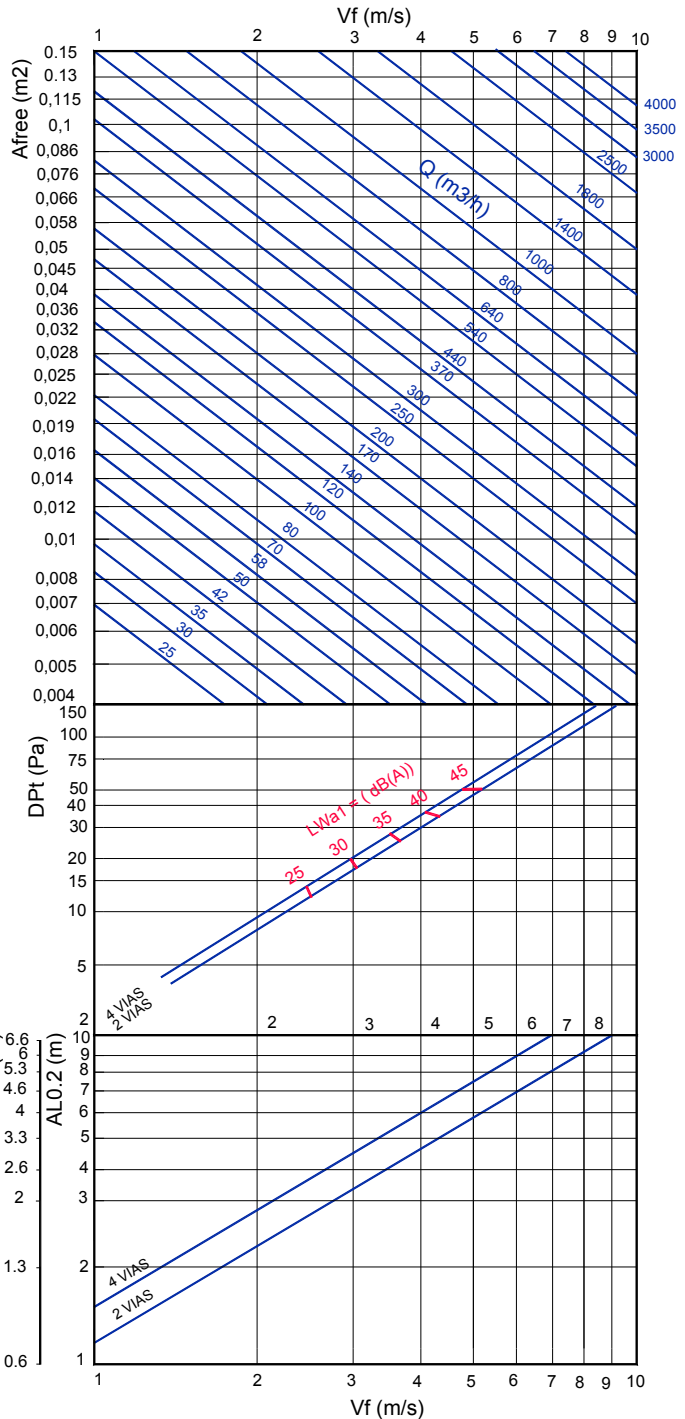
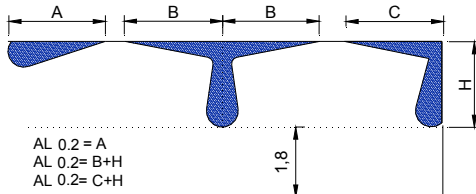

Nota: En MadelMedia Espectro por banda de octava en Hz.

LSD

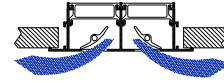

FACTOR DE CORRECCION DE LA DIFUSIÓN VERTICAL (bv) PARA DT (-).

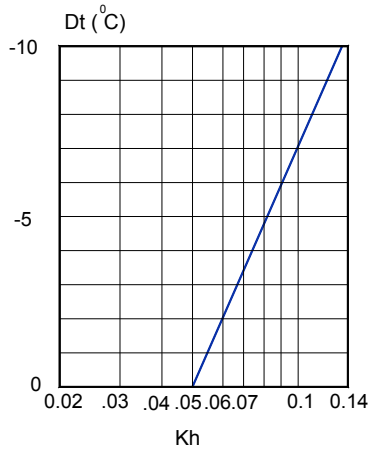

Kh = Factor de corrección de la difusión vertical.

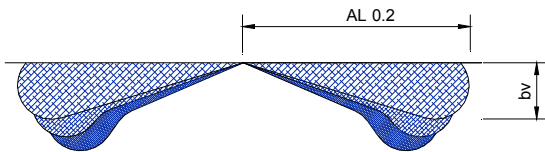

FACTOR DE CORRECCION DEL ALCANCE (L0.2) DT (-).

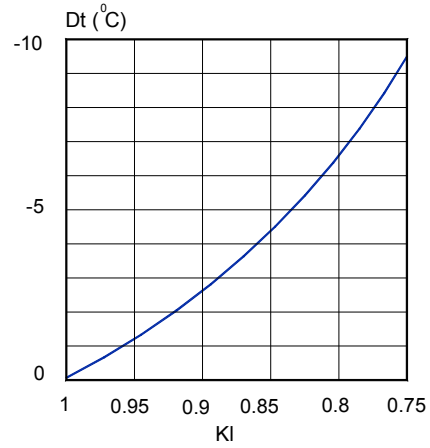

Kl = Factor de corrección del alcance.

$$bv = Kh \times Al_{0.2}$$

$$AL'_{0.2} (Dt < 0) = Kl \times AL_{0.2}$$

RELACION DE TEMPERATURAS.

$$\frac{Dtl}{Dtz} = \frac{t_{local} - t_x}{t_{local} - t_{imp}}$$

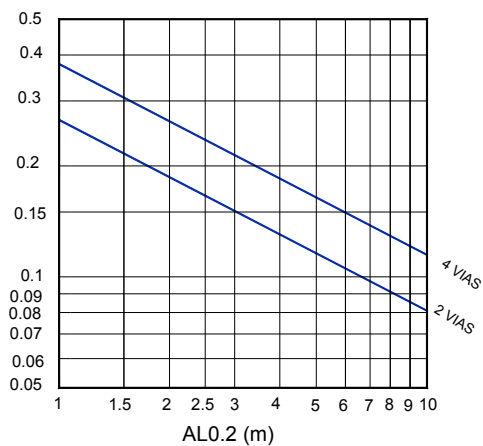

RELACION DE INDUCCION.

$$i = \frac{Q_r}{Q_0} = \frac{Q_{total\ en\ x}}{Q_{de\ impulsión}}$$

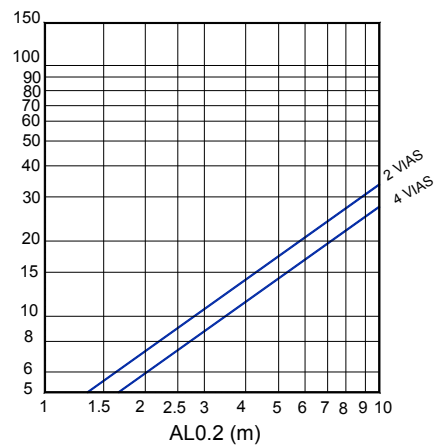

LSD

VELOCIDAD RECOMENDADAS.

VIAS	Vmin (m/s)	Vmax (m/s)
1	2.5	4.5
2	2.5	4.5
3	2.5	4
4	2.5	4

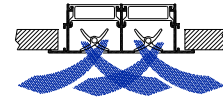
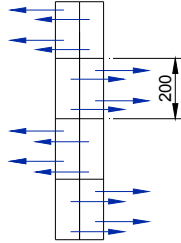

VELOCIDAD LIBRE, PERDIDA DE CARGA Y POTENCIA SONORA, ALCANCE CON EFECTO TECHO: 2 DIRECCIONES.

SECCION LIBRE DE SALIDA DEL AIRE (m2).

	0.5 m	1 m	1.5 m	2 m
1	0.0043	0.0087	0.013	0.0174
2	0.0087	0.0174	0.0261	0.0348
3	0.013	0.0261	0.0391	0.0522
4	0.0172	0.0348	0.052	0.0696

VALORES DE CORRECCION PARA DPT Y Lwa1.

	0.5 m			1 m			1.5 m			2 m			
	100%	50%	0%	100%	50%	0%	100%	50%	0%	100%	50%	0%	
1	Dpt	0.95	2.35	3.15	1	1.4	2.2	1	1.4	2.2	1.1	2.5	3.3
	Lwa1	-6	-3	-3.7	0	+0.8	+0.4	+1	+1.7	+1.2	-2.1	-0.4	-1.9
2	Dpt	0.98	2.48	3.25	1	1.5	2.3	1	1.5	2.3	1.2	2.7	3.5
	Lwa1	-3.7	-3.4	-2.9	0	+0.6	+0.6	+2.4	+3.3	+3.2	-0.5	+0.8	+0.9
	Dpt	0.96	2.26	3.36	1	1.3	2.4	1	1.3	2.4	1.3	2.4	3.5
3	Lwa1	-6.9	-6.3	-5.9	0	+0.9	+0.5	-3	-2.9	-3	-1.8	-1.5	-1.6
	Dpt	0.95	2.35	3.05	1	1.4	2.1	-3	-2.9	-3	1.1	2.5	3.2
4	Lwa1	-3.4	-1.6	-2.4	0	+1.6	+1.2	-2	-1.4	-1.5	-2	-1.3	-1.5

$Dpt1 = Kp \times Dpt$

$Lwa1 = Lwa + Kf$

FACTOR DE CORRECCION DEL ALCANCE KL

	0.5 m	1 m	1.5 m	2 m
1	0.82	1	1.2	1.43
2	0.73	1	1.27	1.34
3	0.8	1	1.17	1.22
4	0.9	1	1.14	1.19

$AL'02 = Kl \times AL02$

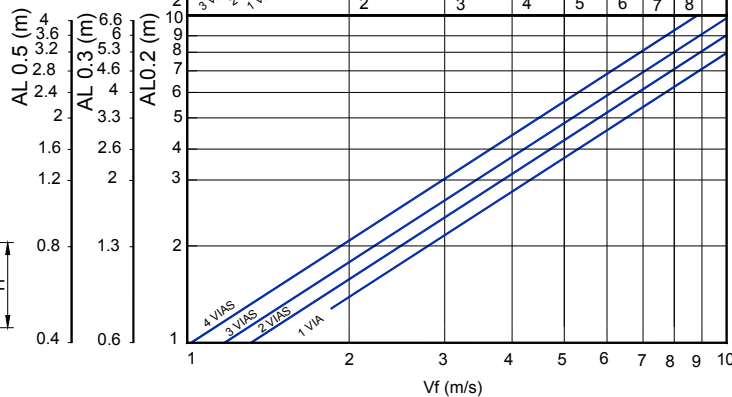
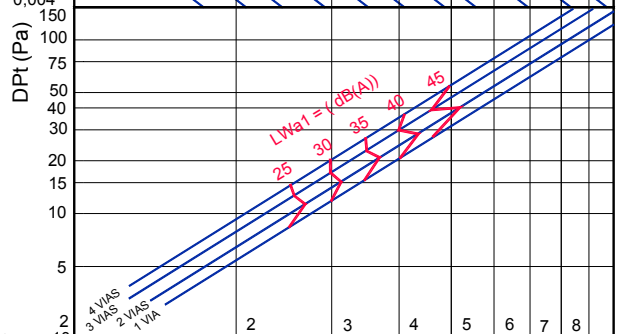
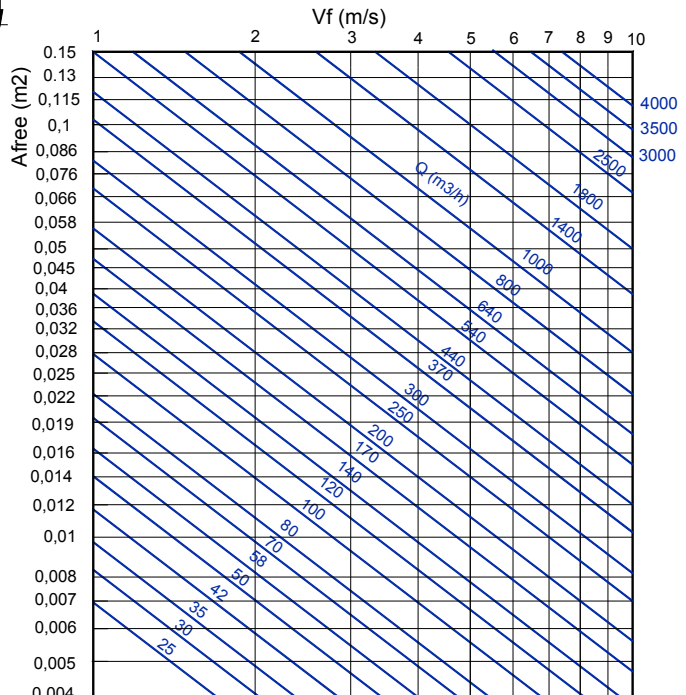
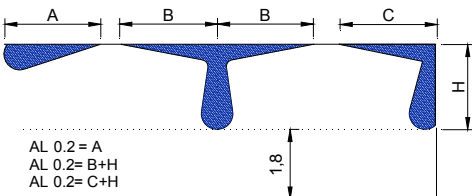

Nota: En MadelMedia Espectro por banda de octava en Hz.

LSD

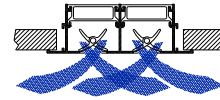

FACTOR DE CORRECCION DE LA DIFUSION VERTICAL (bv) PARA DT (-).

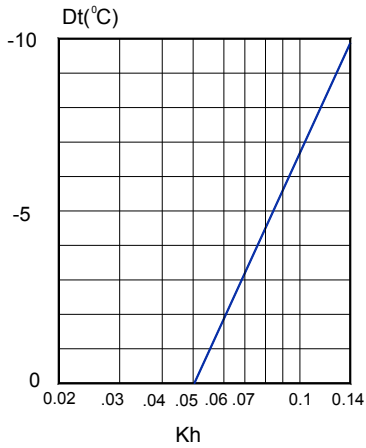

Kh = Factor de corrección de la difusión vertical.

FACTOR DE CORRECCION DEL ALCANCE (L0.2) DT (-).

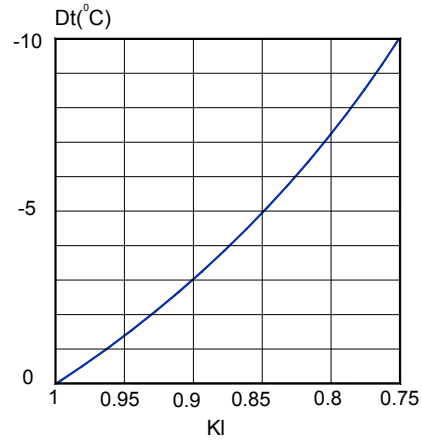

Kl = Factor de corrección del alcance.

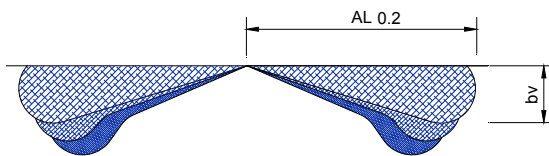

$$bv = Kh \times Al_{0.2}$$

$$AL'_{0.2} (Dt < 0) = Kl \times AL_{0.2}$$

RELACION DE TEMPERATURAS.

$$\frac{Dtl}{Dtz} = \frac{t \text{ local} - t_x}{t \text{ local} - t_{imp}}$$

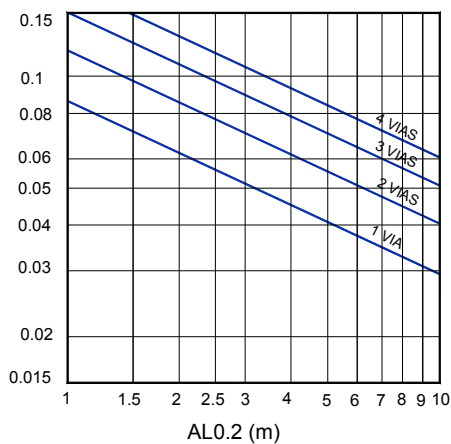

RELACION DE INDUCCION.

$$i = \frac{Q_r}{Q_0} = \frac{Q \text{ total en } x}{Q \text{ de impulsión}}$$

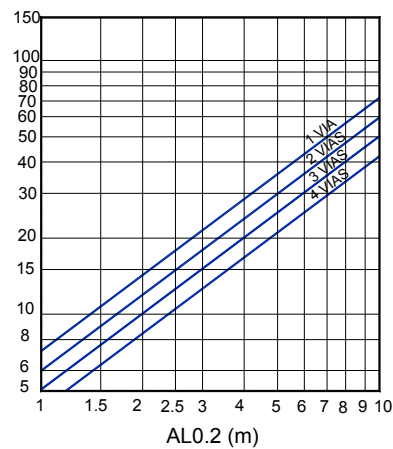

LSD

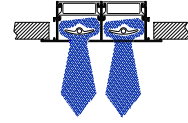

VELOCIDAD RECOMENDADAS.

VIAS	Vmin (m/s)	Vmax (m/s)
1	2.5	4.5
2	2.5	4.5
3	2.5	4
4	2.5	4

VELOCIDAD LIBRE, PERDIDA DE CARGA Y POTENCIA SONORA:
IMPULSION VERTICAL.

SECCION LIBRE DE SALIDA DEL AIRE (m2).

	0.5 m	1 m	1.5 m	2 m
1	0.0043	0.0087	0.013	0.0174
2	0.0087	0.0174	0.0261	0.0348
3	0.013	0.0261	0.0391	0.0522
4	0.0172	0.0348	0.052	0.0696

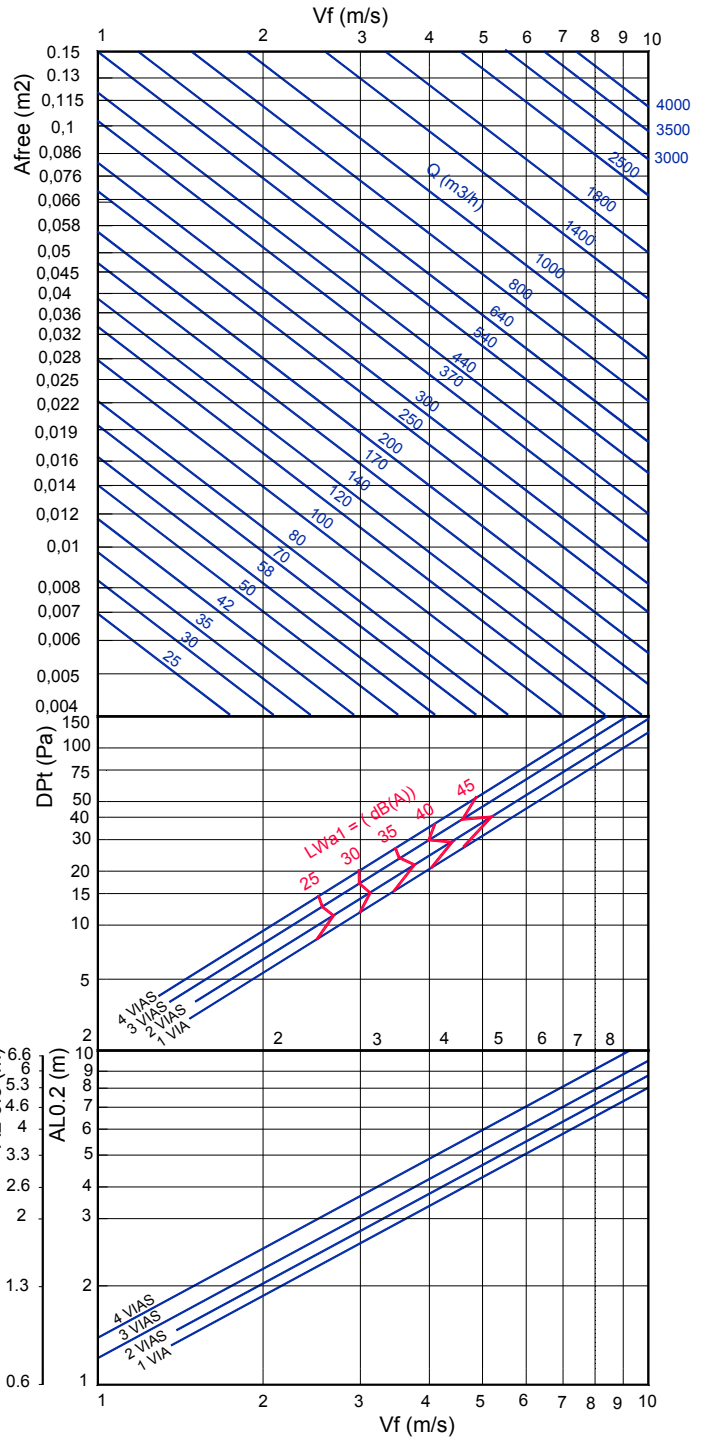

VALORES DE CORRECCION PARA Dpt Y Lwa1.

	0.5 m			1 m			1.5 m			2 m			
	100%	50%	0%	100%	50%	0%	100%	50%	0%	100%	50%	0%	
1	Dpt	0.95	2.35	3.15	1	1.4	2.2	1	1.4	2.2	1.1	2.5	3.3
	Lwa1	-6.1	-3.1	-3.6	0	+0.8	+0.4	+0.9	+1.6	+1	-2.1	-0.5	-1.9
2	Dpt	0.98	2.48	3.25	1	1.5	2.3	1	1.5	2.3	1.2	2.7	3.5
	Lwa1	-3.8	-3.4	-2.9	0	+0.6	+0.6	+2.4	+3.3	+3.2	-0.3	+0.9	+1.1
3	Dpt	0.96	2.26	3.36	1	1.3	2.4	1	1.3	2.4	1.3	2.4	3.5
	Lwa1	-7	-6.3	-6	0	+0.9	+0.5	-2.8	-2.8	-2.9	-1.5	-1.2	-1.3
4	Dpt	0.95	2.35	3.05	1	1.4	2.1	1	1.4	2.1	1.1	2.5	3.2
	Lwa1	-3.4	-1.5	-2.5	0	+1.6	+1.2	-1.9	-1.3	-1.4	-1.9	-1.2	-1.3

$$DPT1 = Kp \times DPT$$

$$Lwa1 = Lwa + Kf$$

FACTOR DE CORRECCION DEL
ALCANCE KL

	0.5 m	1 m	1.5 m	2 m
1	0.7	1	1.1	1.2
2	0.72	1	1.15	1.25
3	0.72	1	1.12	1.2
4	0.74	1	1.25	1.25

$$ALv \cdot 0.2 = Kl \times ALv \cdot 02$$

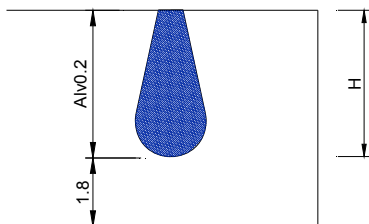

Nota: En MadelMedia Espectro por banda de octava en Hz.

LSD

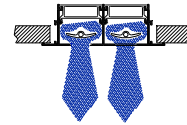

FACTOR DE CORRECCION DEL ALCANCE VERTICAL (ALv 0,2) DT(+).

	D T(+5)	DT(+10)
1 VIA	0.75	0.64
2 VIAS	0.76	0.65
3 VIAS	0.77	0.66
4 VIAS	0.8	0.64

DT = T impulsión - T ocal.

EJEMPLO:

LSD 2VIAS x 2m
 Afree = 0.0348 m².
 Vf = 3.1 m/s.
 ALv 0,2 = 2.9 m.
 ALv'02 = 1.1 x 2.9 = 3.19 m.
 DT(+5) = 0.76 x 3.19 = 2.42 m.
 DT (+10) = 0.65 x 3.19 = 2.07m.

Alv 0,2 (DT +) = Kv x Al 02

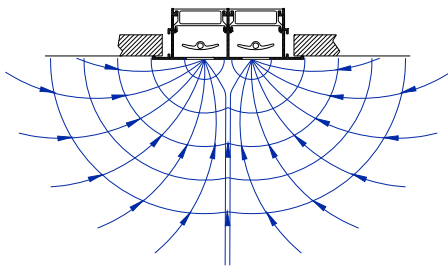

VELOCIDAD RECOMENDADAS.

VIAS	Vmin (m/s)	Vmax (m/s)
1	2	3.5
2	2	3.5
3	2	3
4	2	3

SECCION LIBRE DE SALIDA DEL AIRE (m²).

	0.5 m	1 m	1.5 m	2 m
1	0.0043	0.0087	0.013	0.0174
2	0.0087	0.0174	0.0261	0.0348
3	0.013	0.0261	0.0391	0.0522
4	0.0172	0.0348	0.052	0.0696

VALORES DE CORRECCION PARA Dpt Y Lwa1.

	0.5 m			1 m			1.5 m			2 m			
	100%	50%	0%	100%	50%	0%	100%	50%	0%	100%	50%	0%	
1	Dpt	0.88	2.28	3	1	1.4	2.2	1.3	2.7	3.5	1.5	2.9	3.7
	Lwa1	-	3	5	-	4	7	-	3	5	-	3	7
2	Dpt	0.85	2.35	3.15	1	1.5	2.3	1.4	2.9	3.7	1.66	3.16	3.96
	Lwa1	-	3	5	-	4	7	-	4	7	-	3	8
3	Dpt	0.8	2.1	3.2	1	1.3	2.4	1.2	2.5	3.6	1.4	2.7	3.8
	Lwa1	-	4	5	-	5	8	-	5	8	-	4	8
4	Dpt	0.7	2.1	2.8	1	1.4	2.1	1.3	2.7	3.4	1.5	2.9	3.6
	Lwa1	-	4	5	-	4	8	-	5	8	-	4	8

$Dpt1 = Kp \times Dpt$

$Lwa1 = Lwa + Kf$

VELOCIDAD LIBRE, PERDIDA DE CARGA Y POTENCIA SONORA.

