



CWW
Circular duct heaters
for hot water

CWW

Circular duct heaters for hot water

The CWW with circular duct connections uses hot water as the energy carrier and is used for heating the ventilation air in a ventilation system. The CWW can also be used for heating individual rooms or zones. For controlling the room or supply air temperature, the duct heater is supplemented with regulators, sensors, actuators, valves and anti-freeze protection.

- 15 standard sizes
- Circular duct connection with rubber seal
- Casing of Aluzinc-coated sheet steel, AZ 185
- Openable cover for inspection and cleaning
- Hot water coil with 2 or 3 tube rows
- Air tightness class C to EN 15727

Design

The casing is made of Aluzinc-coated sheet steel, AZ 185. The coil has copper tubes and tube connections, and aluminium fins. An openable cover simplifies inspection and cleaning. The duct connections are provided with rubber seals. The duct heater conforms to air tightness class C to EN 15727.

Operating data

Max. operating temperature: +150°C

Max. operating pressure: 1,0 MPa (10 bar)

The coils are pressure tested and tested for leakage.

Capacity

Examples of capacity for each size are given on pages 4 to 11. You can also do your own calculations using our web-based VEAB Select calculation program (www.veab.com), or get in touch with our sales technicians for assistance.

Installation

The CWW can be installed in a horizontal or vertical duct, with the air flow in either direction.

Control

See pages 12 to 15 for a list of regulators, sensors, valves and actuators.



Air tightness class C

The CWW duct heater conforms to air tightness class C, which ensures that the heated air will reach its destination and will not leak out of the ventilation system – which saves energy and money.

Product range overview and dimensions

Type	Ø D mm	B mm	H mm	Ø dy mm	F mm	G mm	K mm	L mm	Coil inside volume l	Weight kg
CWW 100-2-2.5	100	251	180	10	137	30	276	336	0.13	3.6
CWW 100-3-2.5	100	251	180	10	100	30	276	336	0.20	3.6
CWW 125-2-2.5	125	251	180	10	137	35	276	346	0.13	3.6
CWW 125-3-2.5	125	326	255	10	175	35	276	346	0.20	5.2
CWW 160-2-2.5	160	326	255	10	212	40	276	356	0.29	5.4
CWW 160-3-2.5	160	326	255	10	175	40	276	356	0.42	5.4
CWW 200-2-2.5	200	326	255	10	212	40	276	356	0.29	5.3
CWW 200-3-2.5	200	411	330	22	250	40	276	356	0.42	8.2
CWW 250-2-2.5	250	411	330	22	250	40	276	356	0.66	7.7
CWW 250-3-2.5	250	486	405	22	325	40	276	356	0.96	10.2
CWW 315-2-2.5	315	486	405	22	325	40	276	356	0.98	9.9
CWW 315-3-2.5	315	560	504	22	400	40	276	356	1.35	13.4
CWW 400-2-2.5	400	560	504	22	400	55	276	386	1.36	13.1
CWW 400-3-2.5	400	710	529	22	425	55	330	440	1.87	17.9
CWW 500-2-2.5	500	707	529	22	425	55	330	440	2.55	16.9

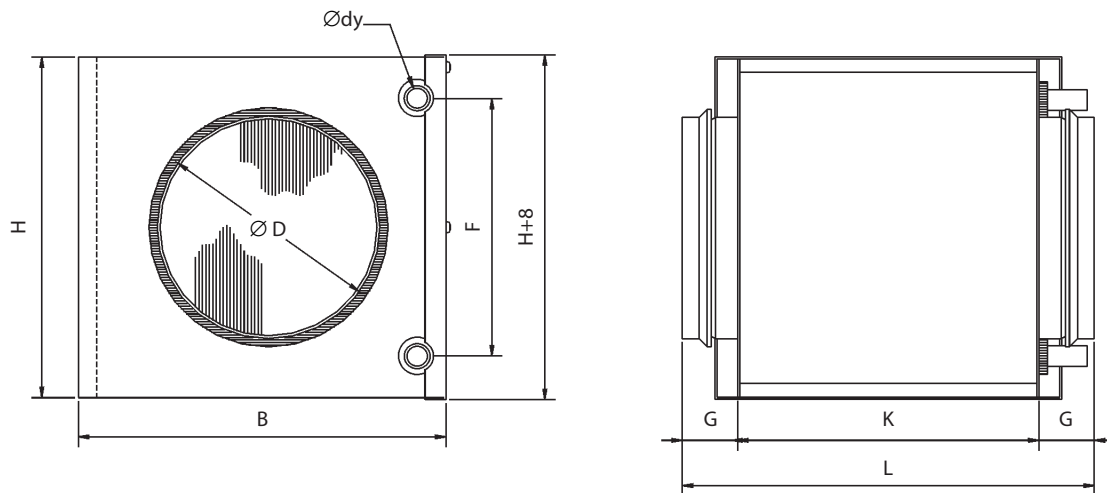

Project design/ordering

Descriptive text for – CWW

VEAB type CWW duct heater with casing made of Aluzinc-coated sheet steel, AZ 185, coil with copper tubes and tube connections, and with aluminium fins. The duct heater conforms to air tightness class C. The heater is controlled by an external regulator, sensors, valves and actuators, which must be ordered separately.

Specify the following for project ordering:

1. Air flow rate: - m³/h
2. Inlet air temperature: - °C
3. Outlet air temp. or required output: - °C or -kW
4. Duct size: - mm
5. Inlet water temp.: - °C
6. Outlet water temp. or water flow: - °C or - l/sec
7. Anti-freeze agent - type / %

Type designation **CWW 100 - 2 - 2.5**

(example)

Size designation

Number of tube rows

Fin pitch, mm

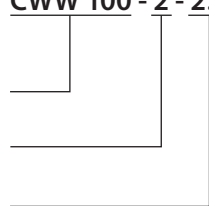

Capacity of CWW 100-2-2,5

Water temp.			in/out 80°C/60°C				in/out 60°C/40°C				in/out 55°C/45°C			
Air flow	Air press. drop	Inlet air temp.	Outlet air temp.	Output	Water flow	Water press. drop	Outlet air temp.	Output	Water flow	Water press. drop	Outlet air temp.	Output	Water flow	Water press. drop
m ³ /h	Pa	°C	°C	kW	l/s	kPa	°C	kW	l/s	kPa	°C	kW	l/s	kPa
55	6	-15	40.1	1.2	0.01	0.4	22.7	0.8	0.01	0.2	27.8	0.9	0.02	1.0
55	6	-7.5	42.7	1.0	0.01	0.4	25.9	0.7	0.01	0.2	30.3	0.8	0.02	0.8
55	6	0	45.0	0.9	0.01	0.3	29.1	0.6	0.01	0.1	32.6	0.6	0.02	0.6
55	6	7.5	47.0	0.8	0.01	0.2	32.1	0.5	0.01	0.1	34.6	0.5	0.01	0.4
55	6	15	48.9	0.6	0.01	0.1	35.1	0.4	0.01	0.1	36.6	0.4	0.01	0.2
100	15	-15	30.2	1.7	0.02	0.9	15.9	1.2	0.01	0.5	20.3	1.3	0.03	2.2
100	15	-7.5	33.7	1.5	0.02	0.7	18.8	1.0	0.01	0.3	23.7	1.2	0.03	1.7
100	15	0	37.1	1.3	0.02	0.6	22.1	0.8	0.01	0.2	27.0	1.0	0.02	1.2
100	14	7.5	40.3	1.2	0.01	0.4	26.1	0.7	0.01	0.2	30.1	0.8	0.02	0.8
100	14	15	43.3	1.0	0.01	0.3	30.0	0.5	0.01	0.1	33.0	0.6	0.02	0.5
145	30	-15	24.2	2.2	0.03	1.5	12.0	1.5	0.02	0.7	15.7	1.7	0.04	3.5
145	29	-7.5	28.3	1.9	0.02	1.2	15.7	1.3	0.02	0.5	19.7	1.5	0.04	2.6
145	28	0	32.3	1.7	0.02	0.9	19.0	1.0	0.01	0.3	23.6	1.2	0.03	1.9
145	27	7.5	36.1	1.5	0.02	0.7	22.8	0.8	0.01	0.2	27.3	1.0	0.02	1.3
145	26	15	39.7	1.2	0.02	0.5	27.3	0.6	0.01	0.1	30.8	0.8	0.02	0.8

Capacity of CWW 100-3-2,5

Water temp.			in/out 80°C/60°C				in/out 60°C/40°C				in/out 55°C/45°C			
Air flow	Air press. drop	Inlet air temp.	Outlet air temp.	Output	Water flow	Water press. drop	Outlet air temp.	Output	Water flow	Water press. drop	Outlet air temp.	Output	Water flow	Water press. drop
m ³ /h	Pa	°C	°C	kW	l/s	kPa	°C	kW	l/s	kPa	°C	kW	l/s	kPa
55	9	-15	57.1	1.5	0.02	1.1	37.1	1.1	0.01	0.6	39.9	1.2	0.03	2.5
55	9	-7.5	58.5	1.3	0.02	0.9	38.1	0.9	0.01	0.4	41.2	1.0	0.02	1.9
55	9	0	59.7	1.2	0.01	0.7	39.2	0.8	0.01	0.3	42.4	0.8	0.02	1.4
55	9	7.5	60.8	1.0	0.01	0.5	40.9	0.6	0.01	0.2	43.4	0.7	0.02	1.0
55	9	15	61.6	0.9	0.01	0.4	42.5	0.5	0.01	0.2	44.2	0.6	0.01	0.6
100	23	-15	46.9	2.4	0.03	2.6	29.9	1.7	0.02	1.4	32.5	1.8	0.04	6.0
100	23	-7.5	49.2	2.1	0.03	2.1	31.9	1.5	0.02	1.0	34.7	1.6	0.04	4.5
100	22	0	51.4	1.9	0.02	1.6	33.6	1.2	0.01	0.7	36.8	1.3	0.03	3.3
100	21	7.5	53.4	1.6	0.02	1.2	34.8	1.0	0.01	0.5	38.7	1.1	0.03	2.3
100	21	15	55.3	1.4	0.02	0.9	36.7	0.7	0.01	0.3	40.4	0.9	0.02	1.5
145	45	-15	40.2	3.1	0.04	4.2	25.0	2.2	0.03	2.3	27.5	2.4	0.06	9.9
145	43	-7.5	43.1	2.7	0.03	3.4	27.6	1.9	0.02	1.7	30.3	2.0	0.05	7.4
145	42	0	45.9	2.4	0.03	2.7	30.1	1.6	0.02	1.2	32.9	1.7	0.04	5.4
145	40	7.5	48.5	2.1	0.03	2.0	32.2	1.3	0.02	0.8	35.4	1.4	0.03	3.7
145	39	15	51.0	1.8	0.02	1.5	33.8	0.9	0.01	0.5	37.8	1.1	0.03	2.4

Capacity of CWW 125-2-2,5

Water temp.			in/out 80°C/60°C				in/out 60°C/40°C				in/out 55°C/45°C			
Air flow	Air press. drop	Inlet air temp.	Outlet air temp.	Output	Water flow	Water press. drop	Outlet air temp.	Output	Water flow	Water press. drop	Outlet air temp.	Output	Water flow	Water press. drop
m ³ /h	Pa	°C	°C	kW	l/s	kPa	°C	kW	l/s	kPa	°C	kW	l/s	kPa
85	12	-15	32.9	1.6	0.02	0.8	17.5	1.1	0.01	0.4	22.3	1.2	0.03	1.8
85	11	-7.5	36.2	1.4	0.02	0.6	20.4	0.9	0.01	0.3	25.5	1.0	0.03	1.4
85	11	0	39.3	1.2	0.01	0.5	23.9	0.7	0.01	0.2	28.5	0.9	0.02	1.0
85	11	7.5	42.2	1.0	0.01	0.4	27.6	0.6	0.01	0.1	31.4	0.7	0.02	0.7
85	11	15	44.8	0.9	0.01	0.3	31.3	0.5	0.01	0.1	33.9	0.6	0.01	0.4
150	31	-15	23.7	2.2	0.03	1.5	11.7	1.5	0.02	0.8	15.3	1.7	0.04	3.7
150	30	-7.5	27.9	2.0	0.02	1.2	15.4	1.3	0.02	0.5	19.4	1.5	0.04	2.7
150	29	0	31.9	1.7	0.02	0.9	18.8	1.0	0.01	0.4	23.3	1.3	0.03	2.0
150	28	7.5	35.7	1.5	0.02	0.7	22.5	0.8	0.01	0.2	27.0	1.0	0.03	1.3
150	28	15	39.4	1.3	0.02	0.5	27.1	0.6	0.01	0.1	30.6	0.8	0.02	0.8
215	61	-15	18.3	2.7	0.03	2.3	8.1	1.9	0.02	1.1	11.2	2.2	0.05	5.5
215	59	-7.5	22.9	2.4	0.03	1.8	12.4	1.6	0.02	0.8	15.7	1.9	0.04	4.1
215	58	0	27.5	2.1	0.03	1.4	16.5	1.3	0.02	0.5	20.1	1.6	0.04	3.0
215	56	7.5	31.8	1.8	0.02	1.1	20.2	1.0	0.01	0.3	24.4	1.3	0.03	2.0
215	54	15	36.1	1.6	0.02	0.8	24.8	0.7	0.01	0.2	28.5	1.0	0.02	1.3

CWW

Capacity of CWW 125-3-2,5

Water temp.			in/out 80°C/60°C				in/out 60°C/40°C				in/out 55°C/45°C			
Air flow	Air press. drop	Inlet air temp.	Outlet air temp.	Output	Water flow	Water press. drop	Outlet air temp.	Output	Water flow	Water press. drop	Outlet air temp.	Output	Water flow	Water press. drop
m ³ /h	Pa	°C	°C	kW	l/s	kPa	°C	kW	l/s	kPa	°C	kW	l/s	kPa
85	6	-15	66.9	2.7	0.03	5.7	47.3	2.0	0.02	3.5	46.4	2.0	0.05	12.6
85	5	-7.5	67.8	2.4	0.03	4.6	48.0	1.8	0.02	2.7	47.2	1.7	0.04	9.6
85	5	0	68.6	2.1	0.03	3.7	48.6	1.5	0.02	2.0	48.0	1.5	0.04	7.1
85	5	7.5	69.3	1.8	0.02	2.9	49.0	1.2	0.02	1.4	48.7	1.2	0.03	5.0
85	5	15	69.9	1.6	0.02	2.2	49.0	1.0	0.01	0.9	49.2	1.0	0.02	3.4
150	12	-15	58.4	4.2	0.05	13.7	40.5	3.2	0.04	8.2	40.4	3.2	0.08	30.6
150	12	-7.5	60.1	3.8	0.05	11.0	42.0	2.8	0.03	6.3	41.9	2.8	0.07	23.3
150	11	0	61.6	3.3	0.04	8.8	43.3	2.3	0.03	4.6	43.3	2.3	0.06	17.2
150	11	7.5	63.0	2.9	0.04	6.8	44.4	1.9	0.02	3.2	44.7	2.0	0.05	12.2
150	11	15	64.2	2.5	0.03	5.2	45.3	1.6	0.02	2.1	45.9	1.6	0.04	8.2
215	20	-15	52.2	5.5	0.07	22.9	35.6	4.2	0.05	13.7	35.9	4.2	0.10	51.8
215	20	-7.5	54.4	4.9	0.06	18.5	37.6	3.6	0.04	10.4	37.9	3.6	0.09	39.5
215	19	0	56.4	4.4	0.05	14.7	39.5	3.1	0.04	7.6	39.9	3.1	0.08	29.1
215	19	7.5	58.3	3.8	0.05	11.5	41.1	2.5	0.03	5.4	41.7	2.6	0.06	20.6
215	18	15	60.1	3.3	0.04	8.7	42.6	2.0	0.02	3.5	43.3	2.1	0.05	13.8

Capacity of CWW 160-2-2,5

Water temp.			in/out 80°C/60°C				in/out 60°C/40°C				in/out 55°C/45°C			
Air flow	Air press. drop	Inlet air temp.	Outlet air temp.	Output	Water flow	Water press. drop	Outlet air temp.	Output	Water flow	Water press. drop	Outlet air temp.	Output	Water flow	Water press. drop
m ³ /h	Pa	°C	°C	kW	l/s	kPa	°C	kW	l/s	kPa	°C	kW	l/s	kPa
145	7	-15	43.2	3.2	0.04	5.5	28.1	2.4	0.03	3.2	29.4	2.5	0.06	12.6
145	7	-7.5	46.1	2.9	0.04	4.4	30.8	2.1	0.03	2.4	32.1	2.1	0.05	9.6
145	7	0	48.8	2.6	0.03	3.5	33.2	1.7	0.02	1.8	34.7	1.8	0.04	7.1
145	7	7.5	51.3	2.2	0.03	2.7	35.4	1.4	0.02	1.2	37.1	1.5	0.04	5.0
145	6	15	53.7	1.9	0.02	2.1	37.2	1.1	0.01	0.8	39.4	1.2	0.03	3.3
250	16	-15	33.5	4.6	0.06	10.9	20.8	3.4	0.04	6.3	22.1	3.5	0.09	25.2
250	16	-7.5	37.1	4.1	0.05	8.8	24.3	2.9	0.04	4.7	25.7	3.1	0.07	19.2
250	15	0	40.6	3.7	0.05	7.0	27.6	2.5	0.03	3.5	29.1	2.6	0.06	14.2
250	15	7.5	44.0	3.2	0.04	5.4	30.7	2.0	0.02	2.4	32.3	2.2	0.05	10.0
250	15	15	47.3	2.8	0.03	4.1	33.6	1.6	0.02	1.5	35.5	1.8	0.04	6.6
355	30	-15	27.4	5.8	0.07	16.6	16.3	4.2	0.05	9.5	17.6	4.4	0.11	38.4
355	29	-7.5	31.6	5.2	0.06	13.4	20.3	3.7	0.04	7.2	21.6	3.8	0.09	29.3
355	29	0	35.6	4.6	0.06	10.7	24.1	3.1	0.04	5.2	25.5	3.3	0.08	21.6
355	28	7.5	39.5	4.0	0.05	8.3	27.8	2.5	0.03	3.6	29.3	2.7	0.07	15.3
355	27	15	43.3	3.4	0.04	6.2	31.3	2.0	0.02	2.2	33.0	2.2	0.05	10.0

Capacity of CWW 160-3-2,5

Water temp.			in/out 80°C/60°C				in/out 60°C/40°C				in/out 55°C/45°C			
Air flow	Air press. drop	Inlet air temp.	Outlet air temp.	Output	Water flow	Water press. drop	Outlet air temp.	Output	Water flow	Water press. drop	Outlet air temp.	Output	Water flow	Water press. drop
m ³ /h	Pa	°C	°C	kW	l/s	kPa	°C	kW	l/s	kPa	°C	kW	l/s	kPa
145	11	-15	59.0	4.1	0.05	13.0	41.0	3.1	0.04	7.8	40.8	3.1	0.08	29.1
145	11	-7.5	60.6	3.7	0.05	10.5	42.4	2.7	0.03	6.0	42.3	2.7	0.07	22.1
145	10	0	62.0	3.2	0.04	8.3	43.6	2.3	0.03	4.4	43.7	2.3	0.06	16.4
145	10	7.5	63.4	2.8	0.04	6.5	44.7	1.9	0.02	3.1	44.9	1.9	0.05	11.6
145	10	15	64.6	2.5	0.03	4.9	45.5	1.5	0.02	2.0	46.1	1.5	0.04	7.8
250	25	-15	49.5	6.2	0.08	28.2	33.5	4.6	0.06	16.8	33.9	4.7	0.11	64.0
250	24	-7.5	51.9	5.5	0.07	22.8	35.7	4.0	0.05	12.8	36.2	4.1	0.10	48.8
250	23	0	54.1	4.9	0.06	18.2	37.8	3.4	0.04	9.4	38.3	3.5	0.08	36.0
250	23	7.5	56.2	4.3	0.05	14.1	39.7	2.8	0.03	6.6	40.3	2.9	0.07	25.5
250	22	15	58.2	3.7	0.05	10.7	41.4	2.3	0.03	4.3	42.2	2.3	0.06	17.0
355	46	-15	42.9	7.9	0.10	45.1	28.5	5.9	0.07	26.6	29.1	6.0	0.15	103.0
355	45	-7.5	45.9	7.0	0.09	36.5	31.2	5.1	0.06	20.2	31.9	5.2	0.13	78.5
355	43	0	48.7	6.2	0.08	29.0	33.9	4.3	0.05	14.8	34.6	4.4	0.11	58.0
355	41	7.5	51.4	5.5	0.07	22.6	36.3	3.6	0.04	10.4	37.1	3.7	0.09	41.0
355	40	15	53.9	4.7	0.06	17.1	38.6	2.9	0.03	6.7	39.6	3.0	0.07	27.3

Capacity of CWW 200-2-2,5

Water temp.			in/out 80°C/60°C				in/out 60°C/40°C				in/out 55°C/45°C			
Air flow	Air press. drop	Inlet air temp.	Outlet air temp.	Output	Water flow	Water press. drop	Outlet air temp.	Output	Water flow	Water press. drop	Outlet air temp.	Output	Water flow	Water press. drop
m ³ /h	Pa	°C	°C	kW	l/s	kPa	°C	kW	l/s	kPa	°C	kW	l/s	kPa
225	14	-15	35.3	4.3	0.05	9.6	22.2	3.2	0.04	5.5	23.5	3.3	0.08	22.1
225	13	-7.5	38.8	3.9	0.05	7.8	25.5	2.8	0.03	4.2	26.9	2.9	0.07	16.9
225	13	0	42.2	3.4	0.04	6.2	28.7	2.3	0.03	3.0	30.2	2.5	0.06	12.5
225	13	7.5	45.4	3.0	0.04	4.8	31.6	1.9	0.02	2.1	33.3	2.0	0.05	8.8
225	12	15	48.5	2.6	0.03	3.6	34.3	1.5	0.02	1.3	36.2	1.6	0.04	5.8
390	36	-15	25.9	6.1	0.07	18.4	15.1	4.5	0.05	10.6	16.4	4.7	0.11	42.9
390	35	-7.5	30.2	5.5	0.07	14.9	19.3	3.9	0.05	8.0	20.6	4.1	0.10	32.8
390	34	0	34.3	4.8	0.06	11.9	23.3	3.3	0.04	5.8	24.6	3.5	0.08	24.2
390	33	7.5	38.3	4.2	0.05	9.2	27.1	2.7	0.03	4.0	28.6	2.9	0.07	17.0
390	32	15	42.3	3.6	0.04	6.9	30.7	2.1	0.03	2.5	32.3	2.3	0.06	11.5
555	69	-15	20.3	7.5	0.09	27.4	11.0	5.5	0.07	15.6	12.2	5.8	0.14	64.1
555	67	-7.5	20.3	7.5	0.09	27.4	15.6	4.8	0.06	11.8	16.8	5.0	0.12	48.9
555	65	0	29.7	5.9	0.07	17.6	20.0	4.0	0.05	8.5	21.3	4.3	0.10	36.1
555	63	7.5	34.1	5.2	0.06	13.6	24.4	3.3	0.04	5.8	25.7	3.6	0.09	25.4
555	61	15	38.5	4.5	0.05	10.2	28.5	2.6	0.03	3.7	30.0	2.9	0.07	16.7

CWW

Capacity of CWW 200-3-2,5

Water temp.			in/out 80°C/60°C				in/out 60°C/40°C				in/out 55°C/45°C			
Air flow	Air press. drop	Inlet air temp.	Outlet air temp.	Output	Water flow	Water press. drop	Outlet air temp.	Output	Water flow	Water press. drop	Outlet air temp.	Output	Water flow	Water press. drop
m ³ /h	Pa	°C	°C	kW	l/s	kPa	°C	kW	l/s	kPa	°C	kW	l/s	kPa
225	8	-15	61.4	6.6	0.08	7.1	42.7	5.0	0.06	4.3	42.6	4.9	0.12	15.9
225	8	-7.5	62.7	5.9	0.07	5.8	43.9	4.3	0.05	3.3	43.8	4.3	0.10	12.1
225	8	0	64.0	5.2	0.06	4.6	44.9	3.7	0.04	2.4	45.0	3.7	0.09	9.0
225	8	7.5	65.1	4.6	0.06	3.6	45.7	3.0	0.04	1.7	46.0	3.0	0.07	6.4
225	8	15	66.1	3.9	0.05	2.7	46.2	2.4	0.03	1.1	47.0	2.5	0.06	4.3
390	19	-15	52.1	10.0	0.12	15.8	35.5	7.5	0.09	9.5	35.9	7.6	0.18	35.8
390	18	-7.5	54.3	8.9	0.11	12.8	37.4	6.5	0.08	7.2	37.9	6.6	0.16	27.3
390	18	0	56.3	7.9	0.10	10.2	39.2	5.5	0.07	5.3	39.8	5.6	0.14	20.2
390	17	7.5	58.2	7.0	0.09	8.0	40.9	4.6	0.06	3.7	41.6	4.7	0.11	14.3
390	17	15	59.9	6.0	0.07	6.0	42.2	3.6	0.04	2.4	43.2	3.8	0.09	9.6
555	34	-15	45.7	12.9	0.16	25.6	30.5	9.6	0.12	15.2	31.2	9.8	0.24	58.1
555	33	-7.5	48.4	11.5	0.14	20.7	33.0	8.3	0.10	11.5	33.7	8.5	0.21	44.4
555	32	0	50.9	10.2	0.13	16.5	35.3	7.1	0.09	8.5	36.2	7.2	0.18	32.8
555	30	7.5	53.3	8.9	0.11	12.8	37.5	5.9	0.07	5.9	38.5	6.0	0.15	23.2
555	29	15	55.6	7.7	0.09	9.7	39.5	4.7	0.06	3.9	40.6	4.9	0.12	15.5

Capacity of CWW 250-2-2,5

Water temp.			in/out 80°C/60°C				in/out 60°C/40°C				in/out 55°C/45°C			
Air flow	Air press. drop	Inlet air temp.	Outlet air temp.	Output	Water flow	Water press. drop	Outlet air temp.	Output	Water flow	Water press. drop	Outlet air temp.	Output	Water flow	Water press. drop
m ³ /h	Pa	°C	°C	kW	l/s	kPa	°C	kW	l/s	kPa	°C	kW	l/s	kPa
360	11	-15	37.4	7.2	0.09	5.9	23.6	5.3	0.06	3.4	25.2	5.5	0.13	13.7
360	11	-7.5	40.7	6.4	0.08	4.8	26.7	4.6	0.06	2.6	28.3	4.8	0.12	10.4
360	10	0	43.9	5.7	0.07	3.8	29.6	3.8	0.05	1.9	31.4	4.1	0.10	7.7
360	10	7.5	46.9	5.0	0.06	3.0	32.3	3.1	0.04	1.3	34.3	3.4	0.08	5.4
360	10	15	49.8	4.3	0.05	2.2	34.7	2.4	0.03	0.8	37.0	2.7	0.07	3.6
630	29	-15	27.7	10.3	0.13	11.6	16.4	7.6	0.09	6.6	17.9	7.9	0.19	27.0
630	28	-7.5	31.8	9.2	0.11	9.4	20.3	6.5	0.08	5.0	21.8	6.9	0.17	20.6
630	27	0	35.8	8.1	0.10	7.5	24.1	5.5	0.07	3.6	25.7	5.8	0.14	15.2
630	26	7.5	39.6	7.1	0.09	5.8	27.7	4.5	0.05	2.5	29.4	4.9	0.12	10.7
630	25	15	43.4	6.1	0.08	4.4	31.1	3.5	0.04	1.5	33.0	3.9	0.09	7.0
900	55	-15	21.9	12.7	0.16	17.4	12.1	9.3	0.11	9.9	13.5	9.8	0.24	40.7
900	53	-7.5	26.5	11.4	0.14	14.1	16.5	8.0	0.10	7.5	18.0	8.5	0.21	31.1
900	52	0	31.0	10.1	0.12	11.2	20.8	6.8	0.08	5.4	22.3	7.3	0.18	22.9
900	50	7.5	35.3	8.8	0.11	8.7	25.0	5.5	0.07	3.7	26.5	6.0	0.15	16.1
900	49	15	39.5	7.6	0.09	6.5	28.9	4.3	0.05	2.3	30.7	4.8	0.12	10.6

Capacity of CWW 250-3-2,5

Water temp.			in/out 80°C/60°C				in/out 60°C/40°C				in/out 55°C/45°C			
Air flow	Air press. drop	Inlet air temp.	Outlet air temp.	Output	Water flow	Water press. drop	Outlet air temp.	Output	Water flow	Water press. drop	Outlet air temp.	Output	Water flow	Water press. drop
m ³ /h	Pa	°C	°C	kW	l/s	kPa	°C	kW	l/s	kPa	°C	kW	l/s	kPa
360	9	-15	61.5	10.5	0.13	8.6	42.9	8.0	0.10	5.2	42.6	7.9	0.19	19.1
360	8	-7.5	62.8	9.4	0.12	6.9	44.0	6.9	0.08	4.0	43.8	6.9	0.17	14.5
360	8	0	64.1	8.3	0.10	5.5	45.1	5.9	0.07	2.9	45.0	5.9	0.14	10.8
360	8	7.5	65.2	7.3	0.09	4.3	45.9	4.9	0.06	2.1	46.1	4.9	0.12	7.7
360	8	15	66.2	6.3	0.08	3.3	46.4	3.9	0.05	1.4	47.0	4.0	0.10	5.1
630	19	-15	52.0	16.1	0.20	19.2	35.4	12.1	0.15	11.5	35.8	12.2	0.30	43.4
630	19	-7.5	54.2	14.4	0.18	15.6	37.4	10.5	0.13	8.8	37.8	10.6	0.26	33.1
630	18	0	56.2	12.8	0.16	12.4	39.2	8.9	0.11	6.5	39.8	9.0	0.22	24.5
630	18	7.5	58.1	11.2	0.14	9.7	40.9	7.4	0.09	4.6	41.6	7.5	0.18	17.4
630	17	15	59.9	9.7	0.12	7.3	42.3	5.9	0.07	3.0	43.2	6.1	0.15	11.6
900	35	-15	45.5	20.8	0.26	31.2	30.4	15.6	0.19	18.5	31.0	15.8	0.38	70.9
900	34	-7.5	48.2	18.6	0.23	25.2	32.9	13.5	0.16	14.1	33.6	13.7	0.33	54.1
900	33	0	50.8	16.5	0.20	20.1	35.3	11.5	0.14	10.4	36.0	11.7	0.28	40.1
900	31	7.5	53.2	14.5	0.18	15.7	37.5	9.5	0.12	7.3	38.4	9.8	0.24	28.4
900	30	15	55.5	12.5	0.15	11.9	39.5	7.6	0.09	4.7	40.6	7.9	0.19	18.9

Capacity of CWW 315-2-2,5

Water temp.			in/out 80°C/60°C				in/out 60°C/40°C				in/out 55°C/45°C			
Air flow	Air press. drop	Inlet air temp.	Outlet air temp.	Output	Water flow	Water press. drop	Outlet air temp.	Output	Water flow	Water press. drop	Outlet air temp.	Output	Water flow	Water press. drop
m ³ /h	Pa	°C	°C	kW	l/s	kPa	°C	kW	l/s	kPa	°C	kW	l/s	kPa
560	11	-15	38,0	11,3	0,14	7,2	24,1	8,4	0,10	4,2	25,6	8,7	0,21	16,6
560	10	-7,5	41,3	10,1	0,12	5,8	27,2	7,2	0,09	3,2	28,7	7,5	0,18	12,7
560	10	0	44,4	9,0	0,11	4,6	30,1	6,1	0,07	2,3	31,7	6,4	0,16	9,4
560	10	7,5	47,4	7,9	0,10	3,6	32,7	5,0	0,06	1,6	34,6	5,3	0,13	6,6
560	10	15	50,2	6,8	0,08	2,7	35,1	3,9	0,05	1,0	37,3	4,3	0,10	4,3
985	27	-15	28,1	16,2	0,20	14,3	16,8	12,0	0,15	8,2	18,2	12,5	0,30	33,2
985	26	-7,5	32,2	14,5	0,18	11,6	20,7	10,3	0,13	6,2	22,1	10,8	0,26	25,3
985	26	0	36,2	12,9	0,16	9,2	24,4	8,7	0,11	4,5	26,0	9,2	0,22	18,7
985	25	7,5	40,0	11,3	0,14	7,1	28,0	7,1	0,09	3,1	29,7	7,7	0,19	13,1
985	24	15	43,7	9,7	0,12	5,4	31,4	5,5	0,07	1,9	33,3	6,2	0,15	8,7
1410	53	-15	22,3	20,1	0,25	21,4	12,4	14,8	0,18	12,2	13,8	15,5	0,38	50,1
1410	52	-7,5	26,9	18,0	0,22	17,4	16,8	12,7	0,15	9,2	18,2	13,5	0,33	38,3
1410	50	0	31,3	15,9	0,20	13,8	21,1	10,7	0,13	6,7	22,5	11,5	0,28	28,2
1410	48	7,5	35,6	14,0	0,17	10,7	25,2	8,8	0,11	4,6	26,7	9,5	0,23	19,9
1410	47	15	39,8	12,0	0,15	8,0	29,2	6,9	0,08	2,9	30,8	7,7	0,19	13,1

CWW

Capacity of CWW 315-3-2,5

Water temp.			in/out 80°C/60°C				in/out 60°C/40°C				in/out 55°C/45°C			
Air flow	Air press. drop	Inlet air temp.	Outlet air temp.	Output	Water flow	Water press. drop	Outlet air temp.	Output	Water flow	Water press. drop	Outlet air temp.	Output	Water flow	Water press. drop
m ³ /h	Pa	°C	°C	kW	l/s	kPa	°C	kW	l/s	kPa	°C	kW	l/s	kPa
560	9	-15	60.7	16.2	0.20	13.0	42.3	12.3	0.15	7.9	42.0	12.2	0.30	29.1
560	9	-7.5	62.1	14.5	0.18	10.5	43.6	10.6	0.13	6.0	43.3	10.6	0.26	22.2
560	9	0	63.4	12.8	0.16	8.4	44.7	9.0	0.11	4.5	44.6	9.0	0.22	16.4
560	9	7.5	64.6	11.3	0.14	6.5	45.7	7.5	0.09	3.2	45.7	7.5	0.18	11.7
560	8	15	65.7	9.7	0.12	5.0	46.4	6.0	0.07	2.1	46.8	6.1	0.15	7.8
985	22	-15	51.0	24.8	0.30	29.4	34.7	18.7	0.23	17.6	35.0	18.8	0.46	66.4
985	21	-7.5	53.2	22.2	0.27	23.8	36.8	16.2	0.20	13.4	37.2	16.3	0.40	50.7
985	20	0	55.4	19.7	0.24	18.9	38.7	13.8	0.17	9.9	39.2	13.9	0.34	37.5
985	20	7.5	57.4	17.3	0.21	14.8	40.5	11.4	0.14	6.9	41.1	11.6	0.28	26.6
985	19	15	59.2	14.9	0.18	11.2	42.1	9.1	0.11	4.6	42.8	9.4	0.23	17.7
1410	40	-15	44.3	32.0	0.39	47.6	29.6	24.0	0.29	28.2	30.1	24.3	0.59	108.5
1410	39	-7.5	47.2	28.6	0.35	38.5	32.2	20.8	0.25	21.5	32.8	21.1	0.51	82.7
1410	37	0	49.9	25.4	0.31	30.7	34.7	17.7	0.22	15.8	35.4	18.0	0.44	61.2
1410	36	7.5	52.4	22.3	0.27	23.9	37.1	14.7	0.18	11.1	37.8	15.0	0.36	43.3
1410	35	15	54.8	19.2	0.24	18.1	39.2	11.7	0.14	7.3	40.1	12.1	0.29	28.9

Capacity of CWW 400-2-2,5

Water temp.			in/out 80°C/60°C				in/out 60°C/40°C				in/out 55°C/45°C			
Air flow	Air press. drop	Inlet air temp.	Outlet air temp.	Output	Water flow	Water press. drop	Outlet air temp.	Output	Water flow	Water press. drop	Outlet air temp.	Output	Water flow	Water press. drop
m ³ /h	Pa	°C	°C	kW	l/s	kPa	°C	kW	l/s	kPa	°C	kW	l/s	kPa
900	12	-15	36.5	17.7	0.22	11.9	23.1	13.1	0.16	6.9	24.5	13.6	0.33	27.4
900	12	-7.5	39.9	15.9	0.19	9.6	26.3	11.3	0.14	5.2	27.7	11.8	0.29	20.9
900	12	0	43.2	14.0	0.17	7.7	29.4	9.6	0.12	3.8	30.9	10.0	0.24	15.4
900	11	7.5	46.3	12.3	0.15	5.9	32.3	7.8	0.10	2.6	33.9	8.3	0.20	10.9
900	11	15	49.3	10.6	0.13	4.5	34.9	6.1	0.07	1.6	36.7	6.7	0.16	7.2
1590	33	-15	26.7	25.3	0.31	23.5	15.8	18.7	0.23	13.5	17.1	19.5	0.47	54.8
1590	32	-7.5	30.9	22.7	0.28	19.1	19.8	16.1	0.20	10.2	21.1	16.9	0.41	41.8
1590	31	0	35.0	20.1	0.25	15.1	23.7	13.6	0.17	7.4	25.1	14.4	0.35	30.8
1590	30	7.5	39.0	17.6	0.22	11.7	27.5	11.2	0.14	5.1	29.0	12.0	0.29	21.7
1590	29	15	42.8	15.1	0.19	8.8	31.1	8.8	0.11	3.2	32.7	9.6	0.23	14.3
2280	65	-15	20.9	31.3	0.38	35.4	11.5	23.0	0.28	20.1	12.7	24.1	0.59	82.8
2280	63	-7.5	25.6	28.0	0.34	28.6	16.0	19.9	0.24	15.2	17.3	21.0	0.51	63.1
2280	61	0	30.2	24.9	0.31	22.7	20.4	16.8	0.20	11.0	21.7	17.9	0.43	46.5
2280	59	7.5	34.6	21.8	0.27	17.6	24.7	13.8	0.17	7.6	26.1	14.9	0.36	32.7
2280	57	15	39.0	18.7	0.23	13.2	28.8	10.8	0.13	4.8	30.3	11.9	0.29	21.5

Capacity of CWW 400-3-2,5

Water temp.			in/out 80°C/60°C				in/out 60°C/40°C				in/out 55°C/45°C			
Air flow	Air press. drop	Inlet air temp.	Outlet air temp.	Output	Water flow	Water press. drop	Outlet air temp.	Output	Water flow	Water press. drop	Outlet air temp.	Output	Water flow	Water press. drop
m ³ /h	Pa	°C	°C	kW	l/s	kPa	°C	kW	l/s	kPa	°C	kW	l/s	kPa
900	11	-15	58.6	25.3	0.31	18.0	40.6	19.1	0.23	10.7	40.5	19.1	0.46	40.4
900	11	-7.5	60.2	22.6	0.28	14.5	42.1	16.6	0.20	8.2	42.0	16.6	0.40	30.7
900	11	0	61.7	20.1	0.25	11.5	43.3	14.1	0.17	6.0	43.4	14.1	0.34	22.6
900	10	7.5	63.1	17.6	0.22	9.0	44.4	11.7	0.14	4.2	44.7	11.8	0.29	16.0
900	10	15	64.3	15.2	0.19	6.8	45.3	9.3	0.11	2.8	45.9	9.5	0.23	10.7
1590	26	-15	48.6	38.6	0.47	40.6	32.8	29.0	0.35	23.9	33.3	29.3	0.71	92.4
1590	25	-7.5	51.1	34.6	0.42	32.8	35.1	25.1	0.31	18.1	35.6	25.5	0.62	70.3
1590	25	0	53.4	30.7	0.38	26.0	37.2	21.4	0.26	13.3	37.8	21.7	0.53	51.8
1590	24	7.5	55.6	26.9	0.33	20.2	39.2	17.7	0.22	9.3	39.9	18.1	0.44	36.5
1590	23	15	57.6	23.2	0.29	15.3	40.9	14.1	0.17	6.0	41.8	14.6	0.35	24.2
2280	51	-15	41.9	49.5	0.61	65.8	27.6	37.1	0.45	38.3	28.3	37.8	0.92	150.7
2280	49	-7.5	44.9	44.4	0.54	53.1	30.5	32.1	0.39	29.0	31.2	32.8	0.80	114.6
2280	47	0	47.8	39.4	0.48	42.1	33.2	27.3	0.33	21.2	34.0	28.0	0.68	84.4
2280	45	7.5	50.5	34.5	0.42	32.7	35.7	22.6	0.27	14.8	36.6	23.3	0.57	59.5
2280	44	15	53.1	29.8	0.37	24.7	38.0	18.0	0.22	9.6	39.1	18.8	0.46	39.4

Capacity of CWW 500-2-2,5

Water temp.			in/out 80°C/60°C				in/out 60°C/40°C				in/out 55°C/45°C			
Air flow	Air press. drop	Inlet air temp.	Outlet air temp.	Output	Water flow	Water press. drop	Outlet air temp.	Output	Water flow	Water press. drop	Outlet air temp.	Output	Water flow	Water press. drop
m ³ /h	Pa	°C	°C	kW	l/s	kPa	°C	kW	l/s	kPa	°C	kW	l/s	kPa
1400	14	-15	34,8	26,6	0,33	16,9	21,8	19,7	0,24	9,5	23,2	20,4	0,50	39,1
1400	14	-7,5	38,4	23,8	0,29	13,6	25,1	17,0	0,21	7,2	26,6	17,7	0,43	29,7
1400	13	0	41,8	21,1	0,26	10,8	28,3	14,3	0,17	5,2	29,9	15,1	0,37	21,8
1400	13	7,5	45,0	18,5	0,23	8,3	31,3	11,7	0,14	3,5	33,0	12,5	0,30	15,2
1400	13	15	48,1	15,9	0,20	6,2	34,0	9,1	0,11	2,2	36,0	10,1	0,24	10,0
2450	38	-15	25,3	37,7	0,46	33,0	14,6	27,8	0,34	18,5	16,0	29,0	0,70	77,3
2450	37	-7,5	29,6	33,7	0,41	26,7	18,8	23,9	0,29	13,9	20,2	25,2	0,61	58,8
2450	36	0	33,8	29,9	0,37	21,1	22,8	20,2	0,25	10,0	24,3	21,5	0,52	43,1
2450	35	7,5	37,9	26,2	0,32	16,3	26,7	16,5	0,20	6,8	28,2	17,9	0,43	30,2
2450	33	15	41,8	22,5	0,28	12,2	30,4	12,9	0,16	4,3	32,1	14,3	0,35	19,7
3500	74	-15	19,7	46,4	0,57	49,4	10,5	34,1	0,41	27,5	11,8	35,8	0,87	116,3
3500	71	-7,5	24,5	41,5	0,51	39,9	15,1	29,4	0,36	20,7	16,4	31,1	0,75	88,4
3500	69	0	29,1	36,8	0,45	31,5	19,6	24,8	0,30	14,9	21,0	26,5	0,64	64,9
3500	67	7,5	33,7	32,2	0,40	24,3	24,0	20,3	0,25	10,1	25,4	22,1	0,54	45,4
3500	65	15	38,1	27,7	0,34	18,2	28,2	15,9	0,19	6,3	29,8	17,7	0,43	29,6

Regulators



AQUA24TF



RC



RC-DO



OPTIGO OP10

AQUA

Complete regulator with built-in room sensor. Floating control for controlling three-position actuators. Cascade connection with minimum limit for room temperature control. Can be equipped with external room and/or duct sensor and external setpoint adjustment. Temperature range 0 - 30°C, depending on the sensor employed.

AQUA24TF

24V supply. The regulator has a built-in controlling anti-freeze protection with two alarm relays and automatic control for heating during stoppage.

REGIO MINI

Complete regulator with built-in room sensor. Can be equipped with external room and/or duct sensors. Has two control outputs, e.g. for heating and cooling in sequence.

RC

24V supply. 0...10V output control signal. DIP switches are used for basic 20 - 26°C setpoint setting. The basic setting can be adjusted by $\pm 3^\circ\text{C}$ by means of the setpoint knob.

RC-DO

24V supply. 0...10V output control signal. The RC-DO has a back-lit display and a temperature range of 0 - 50°C.

OPTIGO

Regulator with display. One knob for all settings. For mounting on DIN rail. Operates with PT1000 sensor in the range of -20°C to $+40^\circ\text{C}$. Started/stopped with "run" signal from the fan.

OP5

24V supply. 0...10V control signal output. Operates with one sensor (room or duct sensor). Can be reset for heating or cooling control.







OP10

24V supply. Can be reset for 0...10V control signal output or 3-point control. Two control outputs, e.g. for heating and cooling in sequence. Input for two sensors and anti-freeze sensor. Supply air temperature control or room temperature control with cascade-controlled supply air. Anti-freeze control with heating during stoppage. Output, e.g. for starting/stopping of fans via 230V~, 5A relay. Programmable one-week timer for controlling of both fan and heating/cooling. Terminal for external timer that extends the operating time. Can be equipped with external setpoint adjuster.





OP10-230

Same functions as the OP10, but with 230V~ supply.

Accessories for AQUA

	Product	Range	Design
	Duct sensor TG-K330	0-30°C	Degree of protection IP20
	Room sensor TG-R430 with setpoint adjustment	0-30°C	Degree of protection IP30
	Room sensor TG-R530	0-30°C	Degree of protection IP30
	Room sensor TG-R630	0-30°C	Degree of protection IP54
	Direct-contact sensor TG-A130 Delivered with clamp.	0-30°C	Degree of protection IP65
	Trafo 60 Totally enclosed transformer for wall mounting. Built-in two- pole fuse on secondary side.		Primary voltage 230V~ Secondary voltage 24V~ Max. rating 60 VA Degree of protection IP44

Accessories for OPTIGO and REGIO

	Product	Range	Design
	Duct sensor TG-K3/PT1000	-30...+70°C	Degree of protection IP20
	Room sensor TG-R5/PT1000	0-50°C	Degree of protection IP30
	Room sensor TG-UH/PT1000	-30...+120°C	Degree of protection IP65
	Direct-contact sensor TG-A130 Delivered with clamp.	-30...+150°C	Degree of protection IP65
	Trafo 60 Totally enclosed transformer for wall mounting. Built-in two- pole fuse on secondary side.		Primary voltage 230V~ Secondary voltage 24V~ Max. rating 60 VA Degree of protection IP44

Actuators and valves for Kv 0.25 – 8.0

(110°C max)

Description		Type
3-position actuator for ZTV/ZTR valves, degree of protection IP44		RVAZ4-24
Actuator for 0...10V signal for ZTV/ZTR valves, degree of protection IP44		RVAZ4-24A
Description	Kv	Type
2-way ½" valve	0.25	ZTV15-0.25
2-way ½" valve	0.4	ZTV15-0.4
2-way ½" valve	0.6	ZTV15-0.6
2-way ½" valve	1.0	ZTV15-1.0
2-way ½" valve	1.6	ZTV15-1.6
2-way ¾" valve	2.0	ZTV20-2.0
2-way ¾" valve	2.5	ZTV20-2.5
2-way ¾" valve	4.0	ZTV20-4.0
2-way ¾" valve	6.0	ZTV20-6.0
2-way 1" valve	8.0	ZTVB25-8.0
3-way ½" valve	0.25	ZTR15-0.25
3-way ½" valve	0.4	ZTR15-0.4
3-way ½" valve	0.6	ZTR15-0.6
3-way ½" valve	1.0	ZTR15-1.0
3-way ½" valve	1.6	ZTR15-1.6
3-way ¾" valve	2.0	ZTR20-2.0
3-way ¾" valve	2.5	ZTR20-2.5
3-way ¾" valve	4.0	ZTR20-4.0
3-way ¾" valve	6.0	ZTR20-6.0
3-way 1" valve	8.0	ZTRB25-8



Actuator RVAZ4-24



Valve ZTV



Valve ZTR



Actuator RVAN5-24



Valve MTVS



Valve MTRS

Actuators and valves for Kv 1.0 – 16.0

(max 185°C)

Description		Type
3-position actuator for MTVS/MTRS valves, degree of protection IP54		RVAN5-24
Actuator for 0...10V signal for MTVS/MTRS valves, degree of protection IP54		RVAN5-24A
Description	Kv	Type
2-way ½" valve	1.0	MTVS15-1.0
2-way ½" valve	1.6	MTVS15-1.6
2-way ½" valve	2.1	MTVS15-2.1
2-way ½" valve	2.7	MTVS15-2.7
2-way ¾" valve	4.2	MTVS20-4.2
2-way ¾" valve	5.6	MTVS20-5.6
2-way 1" valve	10.0	MTVS25-10
2-way 1 ¼" valve	16.0	MTVS32-16
3-way ½" valve	0.63	MTRS15-0.63
3-way ½" valve	1.0	MTRS15-1.0
3-way ½" valve	1.6	MTRS15-1.6
3-way ½" valve	2.1	MTRS15-2.1
3-way ½" valve	2.7	MTRS15-2.7
3-way ¾" valve	4.2	MTRS20-4.2
3-way ¾" valve	5.6	MTRS20-5.6
3-way 1" valve	10.0	MTRS25-10
3-way 1 ¼" valve	16.0	MTRS32-16

Guide for selection of valves and actuators for CWW heaters

110°C max. water temperature

Actuator RVAZ4-24 (3-position) or RVAZ4-24A (0...10V) can be used for all ZTV/ZTR valves.

Type of CWW	Valve type	Kv
CWW 100-2-2,5	2-way ZTV15-0.4 3-way ZTR15-0.4	0.4
CWW 100-3-2,5	2-way ZTV15-0.4 3-way ZTR15-0.4	0.4
CWW 125-2-2,5	2-way ZTV15-0.6 3-way ZTR15-0.6	0.6
CWW 125-3-2,5	2-way ZTV15-0.4 3-way ZTR15-0.4	0.4
CWW 160-2-2,5	2-way ZTV15-0.6 3-way ZTR15-0.6	0.6
CWW 160-3-2,5	2-way ZTV15-0.4 3-way ZTR15-0.4	0.4
CWW 200-2-2,5	2-way ZTV15-0.6 3-way ZTR15-0.6	0.6
CWW 200-3-2,5	2-way ZTV15-1.0 3-way ZTR15-1.0	1.0
CWW 250-2-2,5	2-way ZTV15-1.6 3-way ZTR15-1.6	1.6
CWW 250-3-2,5	2-way ZTV15-1.6 3-way ZTR15-1.6	1.6
CWW 315-2-2,5	2-way ZTV15-1.6 3-way ZTR15-1.6	1.6
CWW 315-3-2,5	2-way ZTV15-1.6 3-way ZTR15-1.6	1.6
CWW 400-2-2,5	2-way ZTV20-2.5 3-way ZTR20-2.5	2.5
CWW 400-3-2,5	2-way ZTV20-2.5 3-way ZTR20-2.5	2.5
CWW 500-2-2,5	2-way ZTV20-4.0 3-way ZTR20-4.0	4.0

185°C max. water temperature

Actuator RVAN5-24 (3-position) or RVAN5-24A (0...10V) can be used for all MTRV/MTRS valves.

Type of CWW	Valve type	Kv
CWW 100-2-2,5	2-way MTRV15-1.0	1.0
CWW 100-3-2,5	2-way MTRV15-1.0	1.0
CWW 125-2-2,5	2-way MTRV15-1.0	1.0
CWW 125-3-2,5	2-way MTRV15-1.0	1.0
CWW 160-2-2,5	2-way MTRV15-1.0	1.0
CWW 160-3-2,5	2-way MTRV15-1.0	1.0
CWW 200-2-2,5	2-way MTRV15-1.0	1.0
CWW 200-3-2,5	2-way MTRV15-1.0	1.0
CWW 250-2-2,5	2-way MTRV15-1.0	1.0
CWW 250-3-2,5	2-way MTRV15-1.6 3-way MTRS15-1.6	1.6
CWW 315-2-2,5	2-way MTRV15-1.6 3-way MTRS15-1.6	1.6
CWW 315-3-2,5	2-way MTRV15-1.6 3-way MTRS15-1.6	1.6
CWW 400-2-2,5	2-way MTRV15-2.1 3-way MTRS15-2.1	2.1
CWW 400-3-2,5	2-way MTRV15-2.7 3-way MTRS15-2.7	2.7
CWW 500-2-2,5	2-way MTRV15-2.7 3-way MTRS15-2.7	2.7

Pressure drops across valves

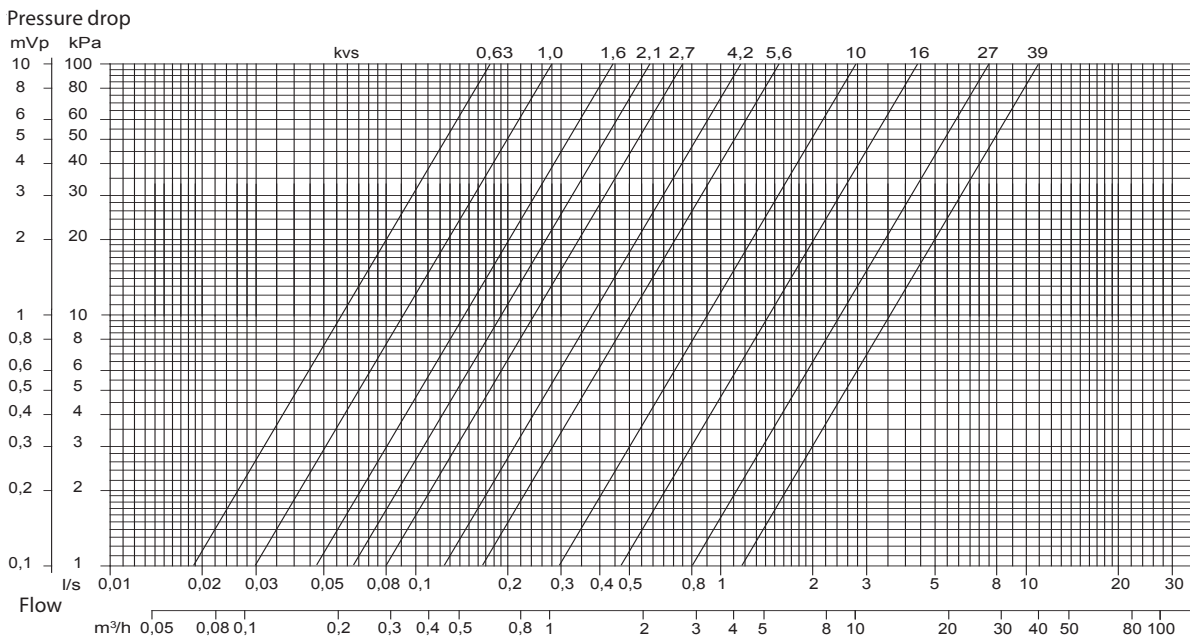



VEAB Heat Tech AB
Phone: +46(0)451-485 00 • Fax: +46(0)451-410 80
www.veab.com • veab@veab.com
Sweden